

RIM DRIVE TECHNOLOGY

# Manual



## 48V Batteries

The best solution for full day operations

## Table of contents

1. Safety guidelines and measures.....	3
1.1 General rules.....	3
1.2 Transport warnings.....	4
1.3 Disposal of Li-ion batteries.....	4
2. General information about LiFePO <sub>4</sub> .....	5
2.1 Rugged.....	5
2.2 Efficiency.....	5
2.3 Dimensions and weight.....	5
2.4 Why is a battery management system (BMS) essential?.....	6
3. Installation.....	7
3.1 Short circuit protection.....	7
3.2 Charge batteries before use.....	8
4. Operation.....	9
4.1 Cell balancing and alarms.....	9
4.2 Charge voltage.....	9
4.3 Maximum discharge voltage.....	9
4.4 Battery Management System (BMS).....	9
5. Recommendations.....	10
5.1 Battery monitor.....	10
5.2 Fuse.....	10

## 1. Safety guidelines and measures

### 1.1 General rules

 Observe these instructions and keep them located near the Li-ion Battery for future reference. Work on the Li-ion Battery should be carried out by qualified personnel only.

 While working on the Li-ion Battery wear protective eye-glasses and clothing.

 Any uncovered battery material such as electrolyte or powder on the skin or in the eyes must be flushed with plenty of clean water immediately. Then seek medical assistance. Spillages on clothing should be rinsed out with water.

 Explosion and fire hazard. Terminals of the Li-ion Battery are always a live; therefore do not place items or tools on the Li-ion Battery. Avoid short circuits, too deep discharges and too high charge currents. Use insulated tools. Do not wear any metallic items such as watches, bracelets, et cetera. In case of fire, you must use a type D, foam or CO<sub>2</sub> fire extinguisher.

 Never try to open or dismantle the Li-ion Battery. Electrolyte is very corrosive. In normal working conditions contact with the electrolyte is impossible. If the battery casing is damaged do not touch the exposed electrolyte or powder because it is corrosive.

 Too deep discharges damage the Li-ion battery seriously and can even be dangerous. Therefore, use of an external safety relay is obligatory.

 Li-ion Batteries are heavy. If involved in an accident they can become a projectile! Ensure adequate and secure mounting and always use suitable handling equipment for transportation. Handle with care because Li-ion Batteries are sensitive to mechanical shock.

 If charged after the Li-ion battery was discharged below the Discharge cut-off voltage, or when the Li-ion battery is damaged or overcharged, the Li-ion battery can release a harmful mixture of gasses such as phosphate.

**Non-compliance with operating instructions, repairs made with other than original parts, or repairs made without authorization render the warranty void.**

### 1.2 Transport warnings

The Li-ion battery must be transported in its original or equivalent package and in an upright position.



If the battery is in its package, use soft slings to avoid damage. Do not stand below a Li-ion battery when it is hoisted.

Never lift the battery at the terminals, only lift the battery at the handles.

For transport the batteries belong to the category UN3480, Class 9, Packaging Group II and have to be transported according to this regulation. This means that for land and sea transport (ADR, RID & IMDG) they have to be packed according to packaging instruction P903 and for air transport (IATA) according to packaging instruction P965. The original packaging satisfies these instructions.

### 1.3 Disposal of Li-ion batteries

Batteries marked with the recycling symbol must be processed via a recognized recycling agency. By agreement, they may be returned to the manufacturer. Batteries must not be mixed with domestic or industrial waste.



## 2. General information about LiFePO<sub>4</sub>

Lithium iron phosphate (LiFePO<sub>4</sub> or LFP) is the safest of the mainstream li-ion battery types. The nominal voltage of a LFP cell is 3.2V. With these cells, depending on the required voltage multiple cells are connected in series.

### 2.1 Rugged

A lead-acid battery will fail prematurely due to sulfation if:

- it operates in deficit mode during long periods of time (i. e. if the battery is rarely, or never at all, fully charged).
- it is left partially charged or worse, fully discharged.

A LFP battery does not need to be fully charged. This is a major advantage of LFP compared to lead-acid. Other advantages are the wide operating temperature range, excellent cycling performance, low internal resistance and high efficiency (see below).

LFP is therefore the chemistry of choice for very demanding applications.

### 2.2 Efficiency

In several applications (especially off-grid solar and/or wind), energy efficiency can be of crucial importance.

The round trip energy efficiency (discharge from 100% to 0% and back to 100% charged) of the average lead-acid battery is 80%.

The round trip energy efficiency of a LFP battery is 92%.The charge process of lead-acid batteries becomes particularly inefficient when the 80% state of charge has been reached, resulting in efficiencies of 50% or even less in solar systems where several days of reserve energy is required (battery operating in 70% to 100% charged state).

In contrast, a LFP battery will still achieve 90% efficiency under shallow discharge conditions.

### 2.3 Dimensions and weight

Saves up to 70% in space

Saves up to 70% in weight

## 2.4 Why is a battery management system (BMS) essential?

Important facts:

1. A LFP cell will fail if the voltage over the cell falls to less than the minimal voltage (note: recovery by charging with a low current, less than 0,1C, is sometimes possible). The installed BMS is configured for the minimal value and is available in the battery specification.
2. A LFP cell will fail if the voltage over the cell increases to more than the maximum voltage. The installed BMS is configured for the maximal value and is available in the battery specification.
3. The cells of a LFP battery do not auto-balance at the end of the charge cycle.

The cells in a battery are not 100% identical. Therefore, when cycled, some cells will be fully charged or discharged earlier than others. The differences will increase if the cells are not balanced/equalized from time to time.

In a lead-acid battery a small current will continue to flow even after one or more cells are fully charged (the main effect of this current is decomposition of water into hydrogen and oxygen). This current helps to fully charge other cells that are lagging behind, thus equalizing the charge state of all cells.

The current through a LFP cell however, when fully charged, is nearly zero, and lagging cells will therefore not be fully charged. Over time the differences between cells may become so extreme that, even though the overall battery voltage is within limits, some cells will fail due to over or under voltage. Cell balancing is therefore highly recommended.

In addition to cell balancing, a BMS will:

- Prevent cell under voltage by timely disconnecting the load.
- Prevent cell over voltage by reducing charge current or stopping the charge process.
- Shut down the system in case of over temperature.

A BMS is therefore indispensable to prevent damage to large Li-ion battery banks.

### Important warning

Li-ion batteries are expensive and can be damaged due to over discharge or over charge.

Damage due to over discharge can occur if small loads (such as: alarm systems, relays, standby current of certain loads, back current drain of battery chargers or charge regulators) slowly discharge the battery when the system is not in use.

In case of any doubt about possible residual current draw, isolate the battery by opening the battery switch, pulling the battery fuse(s) or disconnecting the battery plus when the system is not in use.



### 3. Installation

Batteries should always be installed in an upright position. The system with the battery must have an easily accessible main switch or emergency disconnect.

#### 3.1 Short circuit protection

- Installation with a single battery

The battery should be protected by means of a fuse.

- Series connection

Up to four batteries can be connected in series. The battery bank should be protected by a fuse. Always consult such implementations with the supplier.

Parallel or parallel series connection

Up to four batteries can be connected in parallel. The battery bank should be protected by a fuse. Always consult such implementations with the supplier.

Each battery or battery bank should be protected by means of a fuse, as shown in picture 1.

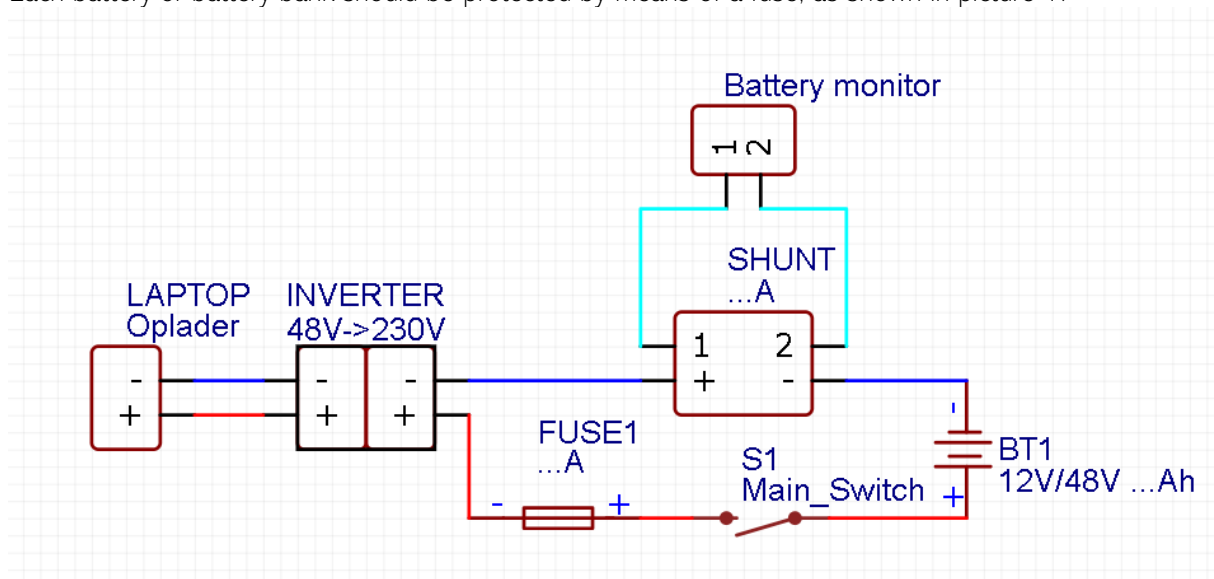

Figure 1: System example of an inverter, laptop charge and battery monitor.

### 3.2 Charge batteries before use

The batteries are approximately 50% charged when shipped.

When charging series connected batteries, the voltage of the batteries or cells with the highest initial state of charge will increase when reaching the fully charged state, while other batteries or cells may lag behind. This may result in over voltage on the batteries or cells with the highest initial state of charge, and the charge process will be interrupted by the BMS.



**We therefore recommend to fully charge new batteries before using them in a series or series-parallel configuration.**

The best for the your battery investment is to charge the batteries individually with a low current charger or with the charger supplied with the battery. Ensure the charger is set to the correct charge voltage and cycle.



## 4. Operation

### 4.1 Cell balancing and alarms

Each consists of cells connected in series, and the internal cell balancing system will:

1. Measure the voltage from each cell and move current from the highest voltage cells to the lowest voltage cells to minimize the voltage differential to less than 10 mV.
2. Gives overvoltage/undervoltage alerts by the BMS.
3. Gives overtemperature ( $T > 75^{\circ}\text{C}$ ) alert by the BMS.
4. Gives under temperature ( $T < 5^{\circ}\text{C}$ ) alert by the BMS

#### Note:

The balance between the cells of batteries connected in series/parallel can be disturbed by high discharge currents combined with short charge cycles. The available battery capacity could be reduced and an over voltage error could occur.

Operate in the manner described in chapter 3.2 to fully charge and equalize the batteries for optimal performance.

### 4.2 Charge voltage

The recommended charging voltage is given by each battery specification document.

In order to prevent damaging the batteries by over discharge, should the battery be charged regularly (at least monthly) to prevent this. The regular charging similarly helps maintaining the cell balance to ensure maximum capacity and endurance.

Besides regularly charging, it is advised for long term storage to use a trickle charger with the advised voltage.

### 4.3 Maximum discharge voltage

The maximum discharge voltage is specified by the used cell type and can be found within the battery specification. It is strongly advised not to discharge the battery below this voltage level in order to prevent damage. If a so called deep discharge is performed, the warranty will be void.

### 4.4 Battery Management System (BMS)

The BMS is integrated within the battery housing. The complete integration ensures easy installation and ensures the correct settings are used to ensure optimal performance and safe operation of the battery.

## 5. Recommendations

### 5.1 Battery monitor

In the case when using a battery for a moving system like a boat, it is strongly advised to use the battery in combination with a battery monitor. The battery monitor provides important information such as the state of charge.

### 5.2 Fuse

In order to prevent damage by short circuit, it is strongly advised to follow the installation instructions given in chapter 3. This will prevent short circuit damage, if the battery is installed without a fuse the operator/installer is themselves responsible for any damages.

# RIM DRIVE TECHNOLOGY



## Uncompromised Electric Motors

[www.rimdrivetechology.nl](http://www.rimdrivetechology.nl)

+31 (0) 85 482 48 55

[info@rimdrivetechology.nl](mailto:info@rimdrivetechology.nl)