

RIM DRIVE TECHNOLOGY

Manual



Joystick Manual

3000 series

Robust proportional fingertip controllers •
non-contacting Hall effect technology



DISTINCTIVE FEATURES

One, two or three axis

Analog - PWM

CAN J1939 & CANopen

Low profile less than 20 mm below panel depth*

5 V or 3.3 V operation

Metal mechanism



ENVIRONMENTAL SPECIFICATIONS

- Operating Temperature: -25 °C to +70 °C
- Storage Temperature: -40 °C to +70 °C
- Sealing: IP65 (above panel subject to handle and final specification)
- EMC Immunity Level: EN61000-4-3 (extended)
- EMC Emissions Level: EN61000-6-3:2001, CISPR 22:2005, Class B 30 MHz-11GHz
- ESD: EN61000-4-2 (extended)



ELECTRICAL SPECIFICATIONS

- Output Voltage Range: $\pm 30\% \times 5.0V$
- Output at Center: $5.0V/2 \pm (5\% \times 30\%)$
- Power Supply: 5 V ± 0.5 V transient free;
- Output impedance: 10 Ω
- Overvoltage max: +20 V



MECHANICAL SPECIFICATIONS

- Operating Force: 1.3 N (2.86 lbf) (Dependant on configuration)
- Maximum Load: 400 N (89.921 lbf) (subject to handle)
- Mechanical Angle of Movement: 36° X & Y axis (subject to limiter)
- Expected Mechanical Life: 10 million lifecycles
- Mass/weight: 100 g (3.53 oz) nominal
- Lever Action (centering): Spring

The company reserves the right to change specifications without notice.

3000 series

Robust proportional fingertip controllers •
non-contacting Hall effect technology



MATERIALS

- Shaft: Stainless steel
- Boot: Neoprene
- Handles:
E, - Nylon



CONNECTIONS

The analog joystick is fitted, as standard, with 150mm long BS6360 rated cables and an industry standard Male Superseal 4-pin connector

CONFIGURATIONS 1 & 2

Joysticks are supplied with a seven way connector as standard. If the joystick is specified with a pushbutton handle, the connector will be nine way.

PIN	FUNCTION	COLOR
4	0V	Black
3	Y Axis Output	Yellow
2	X Axis Output	Blue
1	+V	Red

3000 series

Robust proportional fingertip controllers
non-contacting Hall effect technology



MOUNTING

When mounting the joystick, care should be taken to site it in a position that does not make it vulnerable to damage when in use. If the joystick is intended for use in a handheld enclosure then care must be taken to protect the joystick from damage caused by dropping. Basic precautions such as mounting it at the lightest end of the enclosure so it doesn't hit the ground first or by protecting it with a guard should always be implemented for long term reliability.

The body of the joystick, on the underside of the panel, must not be subject to water spray, excessive humidity or dust. Some handles may be larger than some panel cut-outs. This may restrict the choice of mounting and bezel options. Please refer to APEM for assistance.

DROP-IN MOUNT CUT-OUT AND INSTALLATION

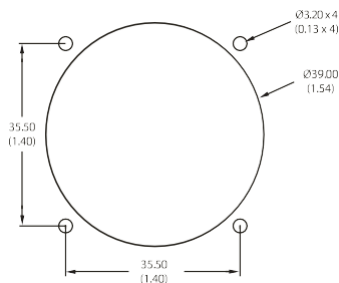

- The joystick is dropped into the panel cut-out.
- For panel thickness of <3 mm, m3 x 16 countersunk machine screws are recommended.
- Please note: Image shows a square bezel, a circular bezel is also available for this option..
- For IP65 panel sealed, a sealing gasket 310062 need to be ordered separately.

OPTION A SUB-MOUNT CUT-OUT AND INSTALLATION

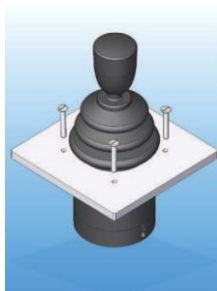
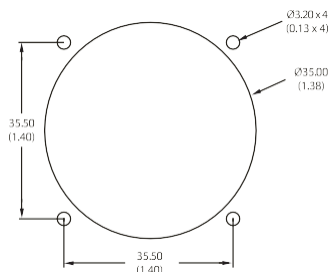

- When mounted this way the panel acts as the bezel and no separate bezel is needed.
- M3 machine screws are recommended..

OPTION B SUB-MOUNT CUT-OUT AND INSTALLATION

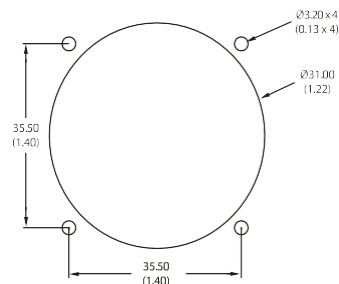

- The joystick is mounted beneath the panel and the base of the boot must be brought through the panel cut-out and held in place with the circular bezel.
- For panel thickness of <3 mm, m3 x 16 countersunk machine screws are recommended.

NOTES:

* 3000 series has slotted mounting holes - allows compatibility with mounting pitches of 32.25 mm to 35.80 mm.

1. Dimensions are in mm/(inch).
2. The dimensions shown are for generic 3000 series with E type handle. For specific dimensions of this or any other configuration please refer to APEM.
3. When sub panel mounting, great care should be taken not to damage the boot, or any of the mechanism under the boot.

All panel cut-outs should be free from sharp edges and debris that may damage the boot.

3000 series

Robust proportional fingertip controllers • non-contacting Hall effect technology



BUILD YOUR PART NUMBER

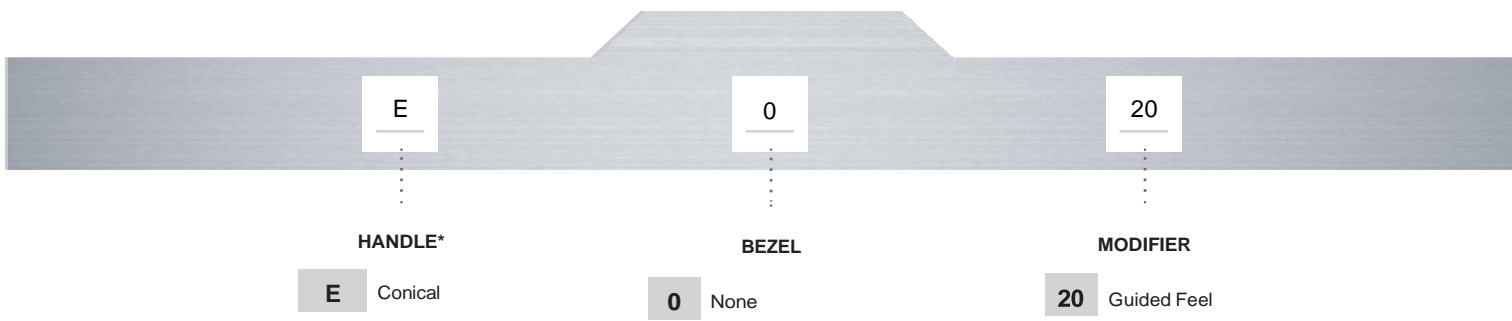
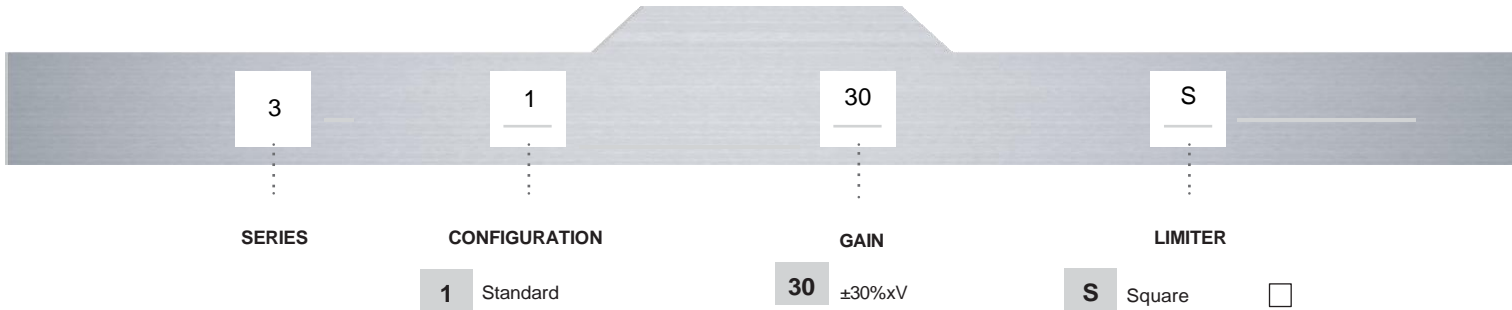

*For more handles see next pages

NOTES :

Standard option availability : The following table shows which permutations of options are possible.

CONFIGURATION	CT	CD	AXIS			SUPPLY		GAIN					LIMITERS						ALL HANDLES	ALL BEZELS				
			X	Y	Z	3.3V	5V	10	25	30	40	50	A	C	D	R	S	X						
1	✓	✓	✓	✓	✓	x	✓	✓	✓	✓	✓	✓	✓	✓	✓	✓	✓	✓	✓	✓	✓	✓	✓	✓
2	x	x	✓	✓	✓	✓	x	x	x	x	x	✓	✓	✓	✓	✓	✓	✓	✓	✓	✓	✓	✓	✓
3	x	x	✓	✓	✓	x	✓	✓	✓	✓	✓	✓	✓	✓	✓	✓	✓	✓	✓	✓	✓	✓	✓	✓
4	x	x	✓	✓	✓	x	✓	✓	✓	✓	✓	✓	✓	✓	✓	✓	✓	✓	✓	✓	✓	✓	✓	✓
5	x	x	✓	✓	✓	x	✓	x	x	x	x	x	✓	✓	✓	✓	✓	✓	✓	✓	✓	✓	✓	✓

3000 series

Robust proportional fingertip controllers
non-contacting Hall effect technology

WITH HANDLE OPTION E

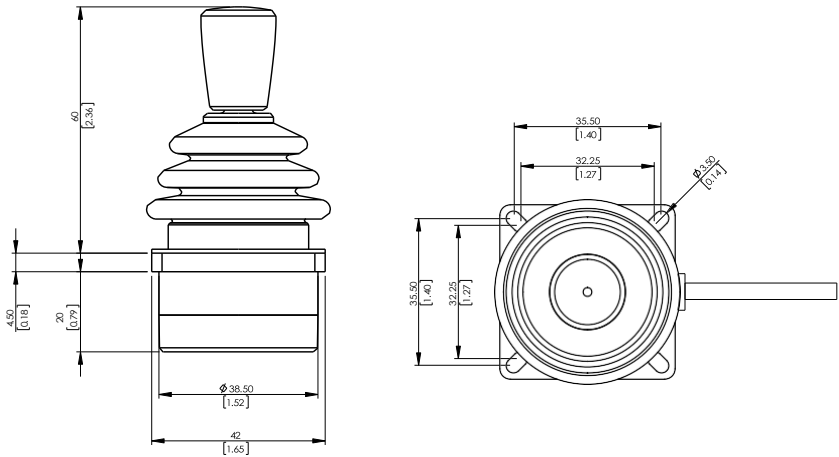

HANDLE OPTIONS

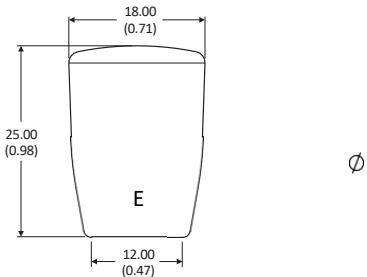

MATERIAL			Nylon	
FINISH			Sparked Matt	
STANDARD COLOR			Black	
NOTES				

3000 series

Robust proportional fingertip controllers
non-contacting Hall effect technology



VOLTAGE OUTPUT OPTIONS

SINGLE OUTPUT - CONFIGURATION 1

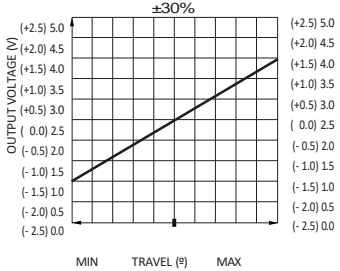

Output 1

3000 series

Robust proportional fingertip controllers •
non-contacting Hall effect technology



CONFIGURATION

POWER SUPPLY

The 3000 series is designed to be powered by a regulated 5 V \pm 0.5 V power supply. The outputs are ratiometric, making a stable, noise free, power supply essential. The power supply to the joystick should be carefully regulated to be within tolerance. Should the power supply change outside of the specified tolerances, permanent damage may occur.

MAGNETIC IMMUNITY AND SYSTEM DESIGN

The 3000 series incorporates internal magnetic screening to minimise the effect of external magnetic fields. Mounting or operating the joystick close to strong magnetic fields is not recommended. System designers should follow best practice when incorporating the 3000 series joystick into their products.

Care should be taken to decouple the power supply properly and to employ adequate EMC shielding.

GAIN OPTIONS

The voltage output on the wipers, at full scale deflection is determined by the gain. The gain is expressed as a percentage of the voltage supplied. Therefore a 5 V supply with a joystick specified with \pm 30 % gain would yield 1 V at South, 2.5 V at center and 4 V at North.

All joysticks are supplied pre-set and no further calibration is needed throughout the lifetime of operation.

OUTPUT IMPEDANCE

The voltage outputs at center and at each end of travel are specified across an infinite load, with no current flowing.

The output impedance specified in the electrical specification should be taken into account when designing a system. Load resistance of less than 10 K Ohms is not recommended.

MECHANISM

The omni-directional mechanism utilizes an extremely robust ball-socket pivot. This construction yields an end product that is extremely resistant to vertical impact.

Furthermore it constantly withstands high pull, push, rotational or horizontal forces that the product may be subject to, during life.

SPRINGING

All 3000 series are offered sprung to center. The standard spring force requires 1.3 N (nominally) to off-center the joystick.

GUIDED FEEL

The 3000 series may also be specified with guided feel. A joystick with guided feel moves more readily towards the poles (N, S, E and W) and whilst it can still move away from the poles, the force required to do so is greater.

RIM DRIVE TECHNOLOGY



Uncompromised
Electric Motors

www.rimdrivetechology.nl

+31 (0) 85 482 48 55

info@rimdrivetechology.nl